

## BASIC TECHNIQUES

**Fit the battery to the power planer**, simply push into the rear of the handle until it clicks into position.

**Use a vice or clamps to hold the work steady and reduce vibration.** At the same time, ensure nothing will get in the power planer's way.

**Hold the planer in both hands and adopt a stable posture with both feet on firm level ground**, do not work in areas where you are forced to stand on loose debris or on a slippery, uneven surface.

**Maintain a good view of the cut** that keeps you clear of the planer's cutters.

**Place the front base plate on the edge of the work, switch ON**, (see GETTING STARTED) **and move the plane forward** over the workpiece in the direction of the wood's grain.

**Apply just enough pressure to keep the sole plate flat on the work** and ensure reasonable forward progress.

**Aim to keep the plane level**, moving at a constant rate along the entire length of the cut. Take special care not to let it wobble from side to side.

**When you reach the end of the workpiece, the front end may drop slightly and remove excess material.** Before using the planer, practice on a piece of waste material.

**Remove the power planer from the workpiece before switching OFF** and wait for the blade to **stop before putting it aside.**

**Never use the planer on timber containing nails** and similar obstructions. It is dangerous and damages the planer's blades.

**To make deep cuts with the planer, remove the waste in gradual stages.** It gives better results and places less strain on the planer.

**When planing across an end grain** (base of a door for example) **clamp a piece of waste material against the end with a sash cramp** or similar to avoid splintering.

## EQUIPMENT CARE

**Never push the equipment beyond its design limits.** If it will not do what you want with reasonable ease and speed, assume you have the wrong tool for the job. Contact your local HSS Hire Shop for advice.

**Keep the equipment clean** - you will find this less of a chore if you clean it regularly, rather than wait until the end of the hire period.

**Handle the planer with care**, avoid knocking or dropping or otherwise damaging it.

**Clean the machine at frequent intervals.** In particular, clean out the planer's ventilation slots. If these get blocked, the motor will overheat and burn out.

**HSS planer blades are double edged, when one edge becomes blunt, simply take the blade out and turn it over.**

**To replace a planer's blades, switch OFF and disconnect the battery, turn it on its side**, then wearing suitable

protective gloves, **rotate the cutter drum to expose the blade assembly.**

Using the hex key provided, **loosen the two retaining screws and slide the blade out from the drum.**

**Next, turn the blade over** (or fit a new blade) then **slide the blade back into the drum and retighten the retaining screws.**

Before using the planer, double **check that the blade assembly is firmly held in place and set so that the right hand edge of the blade is in line with the r/h edge of the base plate.**

**Use only blades supplied by HSS.** The wrong blades could damage both the planer and the workpiece.

**When cleaning or changing blades, though, do remember to switch OFF and disconnect the battery.**

**Never overtighten the hex screws** when making adjustments.

When not in use, **store the equipment somewhere clean, dry and safe** from thieves.

## FINISHING OFF

**Disconnect the battery, then brush off any dust and dirt**, paying particular attention to the motor's ventilation slot.

**Place the power planer, its battery and charger into its carry case ready for return** to your local HSS Hire Shop.



## ...any comments?

If you have any suggestions to enable us to improve the information within this guide please fax your comments or write to the Product Manager at the address below  
**Fax: 020 8687 5001**

©HSS Hire Service Group Plc 2002 No. 400/01

Group Office: 25 Willow Lane, Mitcham, Surrey CR4 4TS

Web Site: <http://www.hss.com>

## Operating & Safety Guide 400

400/01

# HSS Hire Shops

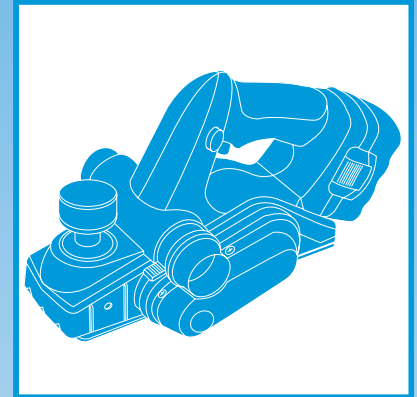

# Cordless Power Planer

**A powerful 14.4V cordless Power Planer with facility to connect to a dust extraction system.**



Code 04113

## GENERAL SAFETY

For advice on the safety and suitability of this equipment, contact your local HSS Hire Shop.



There is a serious risk of personal injury if you do not follow all instructions laid down in this guide.

The hirer has a responsibility to ensure that all necessary risk assessments have been completed prior to the use of this equipment.

This equipment should only be used by an operator who has been deemed competent to do so by his/her employer.

This equipment should be used by an able bodied, competent adult who has read and understood these instructions. Anyone with either a temporary or a permanent disability, should seek expert advice before using it.

Keep children, animals and bystanders away from the work area. Cordon off a NO GO area using either cones, barriers or tape, available for hire from your local HSS Hire Shop.

  Never use this equipment if you are ill, feeling tired, or under the influence of alcohol or drugs.

 Safety goggles MUST be worn by everyone in the work area.

 This equipment generates potentially harmful noise levels. To comply with health and safety at work regulations, ear defenders must be worn by everyone in the vicinity.

 Some materials when planed contain substances which, when inhaled, can be harmful to health. A suitable mask must be worn when using this equipment. Respiratory protective equipment is available for hire, contact your local HSS Hire Shop for details.

   Wear practical, protective clothing, gloves and footwear. Avoid loose garments and jewellery that could catch in moving parts, tie back long hair.

Always ensure that the ON/OFF switch is locked in the OFF position when the Power Planer is not in use. Remove the battery and store it carefully in the carry case provided. Never leave the Power Planer unattended. To safeguard against the risk of fire, never allow the battery terminals to come in contact with metal objects. Ensure the work area is well lit and adequately ventilated. Dust extraction and ventilation equipment is available for hire, contact your local HSS Hire Shop for information and advice.

Keep the work area tidy, do not work in areas where you are forced to stand on loose debris or on a slippery uneven surface.

Do not work near flammable gases or liquids, petrol or paint thinner fumes for example. Keep combustible materials at a safe distance - at least 5m.

Make sure you know how to switch this machine OFF before you switch it ON in case you get into difficulty.

The planer must only be used for removing material from clean, untreated wood/timber products.

Never switch the planer ON if in contact with the work – it may kick back and cause personal injury.

The blade is not guarded at the base, to avoid injury, hold the planer by its handle.

Take special care when changing cutters – they are sharp.

Never use the power planer on asbestos sheeting, or any other material that may yield hazardous dust.

Make sure that everyone is warned of what you are doing.

Check the condition of the equipment before use. If it shows signs of damage or excessive wear, return it to your local HSS Hire Shop.

## ELECTRICAL SAFETY

The battery charger is designed to plug straight into a standard 230V 13 amp power socket.

To remove the battery from the power planer, press the lock tabs in with finger and thumb and pull the battery clear.

To recharge, insert the battery pack into the charger, it will only go in one way. Then plug the charger into a suitable power supply and switch the power ON, recharging is fully automatic.

The green indicator lamp will blink while the battery is being charged and will remain on once charging is complete.

The charger will recharge the battery in approximately 1 hour.

If an extension lead is used for the charger, it should be fully unwound and loosely coiled, away from the equipment. Never run leads through water, over sharp edges or where they could trip someone.

Using the charger in very damp or wet conditions can be dangerous.

To reduce the risk of electric shock, use a suitable RCD (Residual Current-Operated Device) available from your local HSS Hire Shop, or power the charger from a mains circuit with a built-in RCD.

If the power planer fails, or if the charger's power supply cable or plug gets damaged, return it. Never try to repair it yourself.

Never carry or pull the charger by its power supply cable.

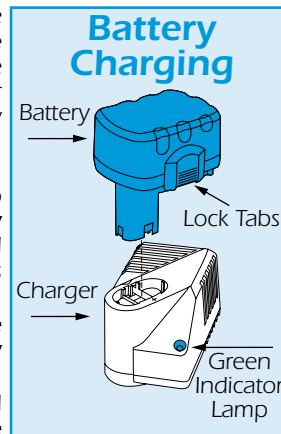

## GETTING STARTED

Before operating a power plane, adjust the depth of cut using the depth knob, graduated in mm (0mm, 0.5mm, 1mm, 1.6mm). Turn clockwise/anticlockwise to increase/decrease the depth.

## Planing Depths

The 'depth of cut' setting on a power planer determines both the quality of the finish and the rate at which you remove waste. In general, use a deep cut for roughly sizing timber and shallow cut for final smoothing.

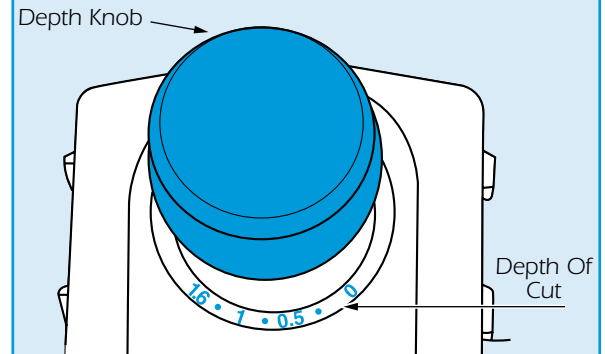

To reduce the amount of dust entering the atmosphere, connect the planer to a dust extraction unit available from HSS Hire Shops. You can connect either to the left hand or right hand outlet but do ensure that you set the direction lever for the side selected (see illustration).

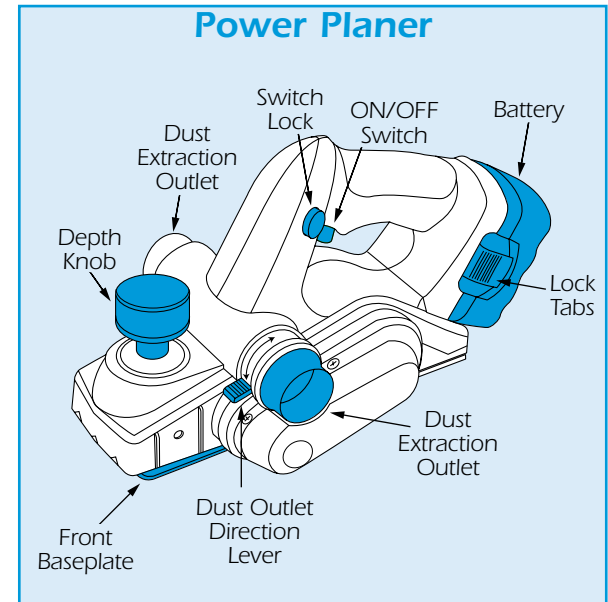

The power planer is fitted with an ON/OFF switch lock, which prevents accidental operation of the unit. The spring loaded lock is manually operated and must be moved either to the left or right to release the ON/OFF switch.

To switch the planer ON, push the lock OFF button in with your thumb, then squeeze the ON/OFF trigger. To switch the planer OFF, simply release the trigger.