

# HSS Hire

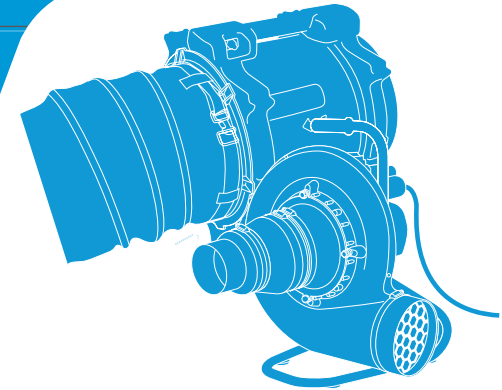

## Fume Extractors

For the removal of fumes from work areas and confined spaces.



Code 56801/56811

**Handle the equipment with care**, avoid dropping it, knocking it, or otherwise exposing it to damage.

**Never expose the equipment to excessive moisture, dust or dangerous/corrosive chemicals.**

**When not in use, store the equipment somewhere clean, dry and safe from thieves.**

### FINISHING OFF

**Switch OFF and unplug the unit, then disconnect any hoses.**

**Finally, neatly coil the cables** ready for return to your local HSS Hire.



#### ... have you been trained

The law requires that personnel using work equipment have received adequate training and must be competent when using the equipment within the workplace.

Training is available at HSS Training Solutions

0845 766 7799

#### ...any comments?

If you have any suggestions to enable us to improve the information within this guide please e-mail your comments or write to the Safety Guide Manager at the address below  
e-mail: [safety@hss.com](mailto:safety@hss.com)

©HSS Hire Service Group Ltd 2008 No. 713/03

Group Office: 25 Willow Lane, Mitcham, Surrey CR4 4TS

Web Site: <http://www.hss.com>

## GENERAL SAFETY

For advice on the safety and suitability of this equipment contact your local HSS Hire Shop.



There is a serious risk of personal injury if you do not follow all instructions laid down in this guide.

The hirer has a responsibility to ensure that all necessary risk assessments have been completed prior to the use of this equipment.

This equipment should only be used by an operator who has been deemed competent to do so by his/her employer.

This equipment should be used by an able bodied, competent adult who has read and understood these instructions. Anyone with either a temporary or permanent disability, should seek expert advice before using it.

Keep children, animals and bystanders away from the work area. Cordon off a NO GO area using cones and either barriers or tape, available for hire from your local HSS Hire Shop.

  Never use this equipment if you are ill, feeling tired, or under the influence of alcohol or drugs.

 Fumes of any kind, if inhaled, can be harmful to health. It is not guaranteed that this equipment will remove all fumes from the area. Therefore a suitable mask must be worn when using this equipment. Respiratory protective equipment is available for hire, contact your local HSS Hire for details.

  Wear practical, protective clothing, gloves and footwear. Avoid loose garments and jewellery that could catch in moving parts, tie back long hair.

**DO NOT REMOVE** the guards fitted to this equipment, keep hands away from the motor.

Keep the power unit's air vents clear of all obstructions.

Do not carry, lift or pull this equipment by its power supply cable or air hoses.

Always switch equipment **OFF** before making any adjustments to it. **Never leave** it switched **ON** and unattended.

Ensure the work area is well lit, if in doubt, ask about lighting equipment at your local HSS Hire.

Do not work near flammable gases or liquids, petrol or paint thinner fumes for example. Keep combustible materials at a safe distance – at least 5m.

Check the condition of the equipment before use. If it

shows signs of damage or excessive wear, return it to your local HSS Hire.

## ELECTRICAL SAFETY

Most HSS equipment is designed to plug straight into a standard 230V 13A power socket. However, **110V equipment** (with a round, yellow plug) **must be supplied from either a 110V generator or from the mains via a suitable transformer.**

If the equipment fails, or if its power supply cable or plug becomes damaged, return it. Never try to repair it yourself.

Keep cables out of harm's way, and clear of the work area.

Extension leads should be fully unwound and loosely coiled, away from the equipment. Never run them through water, over sharp edges or where they could trip someone.

Keep the equipment dry, using electrical equipment in very damp or wet conditions can be dangerous.

 To reduce the risk of electric shock, always use a **RCD** suitable RCD (Residual Current-Operated Device) available from your local HSS Hire . Or power the equipment from a mains circuit with a built in RCD.

Ensure the unit and the power socket are **switched OFF** before plugging into the power supply.

## GETTING STARTED

Never use a fume extractor in an explosive atmosphere. Instead, set it up as far from the contaminated area as possible, with its hose connected to the OUT end.

Having opened all doors and windows, you can now blow air in to disperse the fumes.

If extracting from the room through the unit, ensure that the fumes are only discharged into the open air and away from any people. **DO NOT** discharge into another room.

Connect the hoses as required, i.e. either a hose to the inlet and outlet or only one hose to either dependant on where the fumes are being moved from (see diagram).

Both metal and plastic models are fitted with a ON/OFF toggle switch either fitted to the top body or the rear left hand leg.

To switch the unit ON move the switch to the ON position, to switch the unit OFF, move the switch to the OFF position.

## Steel Case Fume Extractor

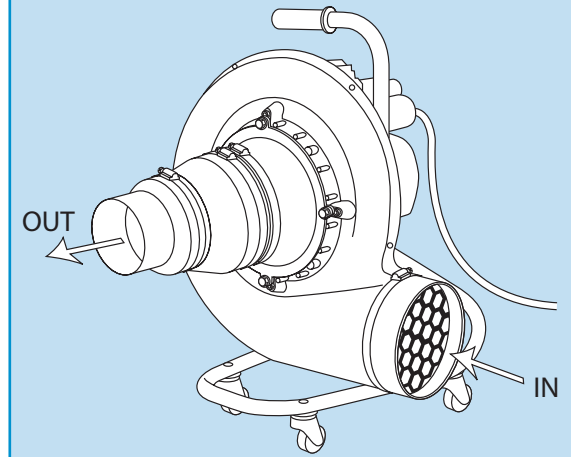

## Plastic Case Fume Extractor

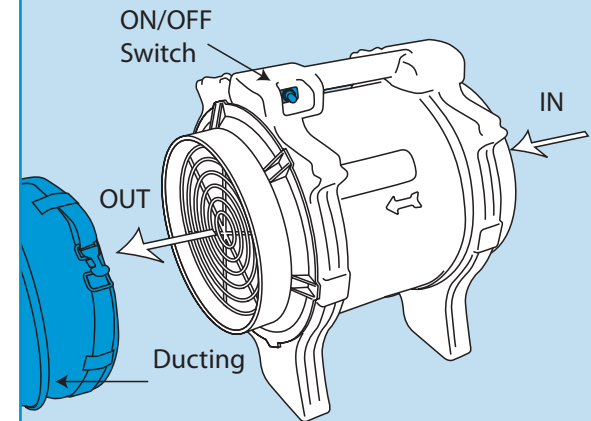

## EQUIPMENT CARE

**Never push the equipment beyond its design limits.** If it will not do what you want with reasonable ease and speed, assume you have the wrong type or size of extractor for the job. **Ask at your local HSS Hire for advice.**

**Keep the equipment clean.** You will find this less of a chore if you clean it up regularly rather than wait until the end of the hire period.