

If drilling into timber, metal or plastic, turn the selector to drill only.

The direction of rotation is selected using the forward/reverse switch, just above the trigger (see illustration). Push to the right for forward and to the left for reverse. Placing the switch centrally will lock the trigger, this feature should be used whenever the drill is not being used.

Speed of rotation is controlled via the variable speed trigger, from 0 to 890rpm. The more the trigger is squeezed, the faster the bit rotates. As a rule of thumb, the harder the material and /or the larger the hole, the slower the drill speed.

BASIC TECHNIQUES

Connect a charged battery to the unit (see ELECTRICAL SAFETY).

To start the drill, squeeze in the ON/OFF trigger, to stop simply release the trigger.

Hold the machine in both hands and adopt a stable stance that gives you a good view of the work while keeping you clear of the bit.

Do not work in areas where you are forced to stand on loose debris or on a slippery uneven surface.

Start drilling slowly and carefully, then once the hole is established, concentrate on drilling in a straight line - with the drill at right angles to the surface, where appropriate.

Apply just enough pressure to achieve a steady rate of penetration - too much or too little pressure will overheat and/or blunt the drill bit and could damage the electric motor.

When drilling into hard material such as masonry, withdraw the bit from time to time, keeping the drill running, in order to cool it and the drill motor. This will also clear waste from the hole.

If you wish to use the drill as a screwdriver, use an adapter to hold the various driver tips.

When drilling large diameter holes with TCT or HSS twist bits, drill a small pilot hole first then drill again with a larger bit, until the correct size is achieved.

If using a flat blade for timber, do not use a pilot as the flat bit relies on its own pilot tip to keep the blade central.

EQUIPMENT CARE

Never push the drill beyond its design capabilities. If it won't do the job you want with reasonable ease, contact your local HSS Hire Shop for advice.

Never let the drill bit or motor over-heat. Stop work at frequent intervals and run the drill for a minute or so, just holding it in your hands. The air drawn in and around it will cool everything down and prevent damage.

Regularly check that the air vents in the drill body are clear. If these become blocked with dust, clean them out using a soft brush before continuing, taking care not to push dirt into the drill body.

When not in use, store the equipment somewhere clean, dry and safe from thieves.

FINISHING OFF

Remove all drill bits and neatly coil the chargers flex and place in the carrying case ready for return to your local HSS Hire Shop.



...any comments?

If you have any suggestions to enable us to improve the information within this guide please fax your comments or write to the Product Manager at the address below

Fax: 020 8687 5001

©HSS Hire Service Group Plc 1999 No. 908/01
Group Office: 25 Willow Lane, Mitcham, Surrey CR4 4TS

Web Site: <http://www.hss.co.uk>

HSS Hire Shops

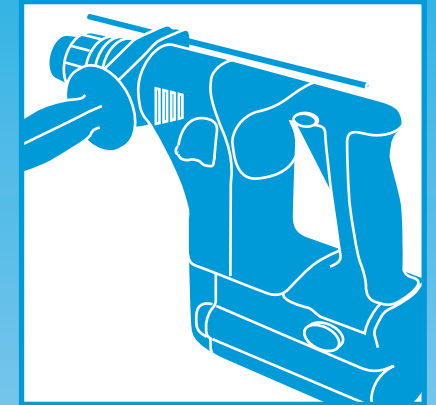

36V Cordless Hammer Drill

The latest generation of cordless drill, with the power to drill holes up to 16mm diameter into masonry.



GENERAL SAFETY

For advice on the safety and suitability of this equipment contact your local HSS Hire Shop.

There is a serious risk of personal injury if you do not follow all instructions laid down in this guide.

This equipment should be used by an able bodied, competent adult who has read and understood these instructions. Anyone with either a temporary or permanent disability, should seek expert advice before using it.

Keep children, animals and bystanders away from the work area.

 Never use this equipment if you are ill, feeling tired, or under the influence of alcohol or drugs.

 Safety goggles MUST be worn by everyone in the work area.

 Some materials when drilled contain substances which, when inhaled, can be harmful to health. A suitable mask must be worn when using this equipment. Dust extraction and respiratory protective equipment is available for hire, contact your local HSS Hire Shop for details.

 This equipment generates potentially harmful noise levels. To comply with health and safety at work regulations, ear defenders must be worn by everyone in the vicinity.

 Wear practical, protective clothing, gloves and footwear. Avoid loose garments and jewellery that could catch in moving parts, tie back long hair.

Always switch OFF the equipment when not in use.

Ensure the work area is well lit and ventilated, if in doubt, ask about site lighting and ventilation equipment at your local HSS Hire Shop.

Never use the equipment if highly flammable vapours – petrol or paint thinner fumes for example – are present.

Always switch OFF and unplug the charger when not in use.

Take special care when changing drill bits – they are sharp.

Always disconnect the battery from the drill before making adjustments to it. Check that it is switched OFF before re-connecting the battery.

Having switched OFF, always wait for the drill bit to come to rest before putting the drill down.

Check the condition of the equipment before use. If it shows signs of damage or excessive wear, return it to your local HSS Hire Shop.

Make sure you know how to switch this machine OFF before you switch it ON, in case you get into difficulty.

Never carry or pull the charger by its power supply cable.

Only change the drill's direction of rotation when the machine has stopped.

Take special care when drilling into walls or floors, they may contain hidden pipework, reinforcing bars or electrical cables. If in doubt, hire a metal locator, to determine the exact position of such hazards.

Watch your footing. Take special care if working other than on firm, level ground. Above ground-level, ALWAYS work from a stable, purpose-made work platform such as a step-up or trestle.

ELECTRICAL SAFETY

Battery Charger

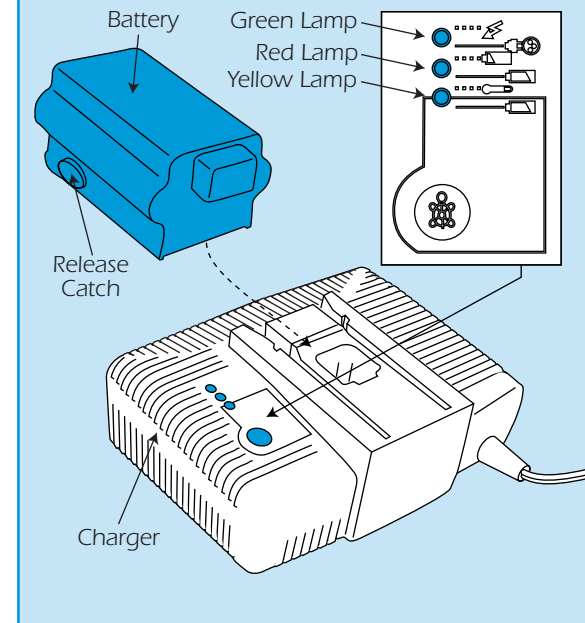

The battery charger is designed to plug straight into a standard 240V 13A power socket.

To recharge the battery, firstly remove it from the drill. Simply hold in the two release catches and slide the battery back, until clear of the drill.

To replace the battery, insert the battery onto the drills body until it clicks into position.

Slide the battery pack into the charger, it will only go in one way, until you hear a click. Then plug the charger into a suitable power supply and switch the power ON.

There are 3 lamps on the charger that indicate battery condition and charging status.

When the power supply is switched ON, the green lamp will illuminate. However, if the lamp flashes, this indicates a fault either with the charger or the battery. Should this happen, contact your local HSS Hire Shop for advice.

The red lamp illuminates to indicate that charging is in progress and will flash once charging is complete.

The yellow lamp will flash if charging is halted, this will occur if the battery is either too hot or too cold. If the lamp does flash, leave the battery to either cool or warm, charging will continue automatically once the battery is at a suitable temperature.

The charger will recharge the battery in approximately 32 minutes.

Using the charger in very damp or wet conditions can be dangerous.

 To reduce the risk of electric shock, always use a suitable RCD (Residual Current-Operated Device) available from your local HSS Hire Shop, or power the charger from a mains circuit with a built-in RCD.

If the tool fails, or if the charger's power supply cable or plug gets damaged, return it. Never try to repair it yourself.

If an extension lead is used for the charger it should be fully unwound and loosely coiled, away from the equipment. Never run leads through water, over sharp edges or where they could trip someone.

GETTING STARTED

The drill and charger will be supplied in a carrying case and you may find that the side handle will need to be fitted, simply slide the handle assembly over the drills body, then secure in place by twisting the handle clockwise.

The side handle MUST be fitted and used, if the bit jams during drilling the side handle will help restrain the machine. Without the handle fitted you risk serious injury.

Fit the drill with right bit for the job.

Open the chuck by turning the rear collar anti-clockwise until the 'open' symbol aligns with the line mark. Insert the drill bit and re-lock the chuck by turning the rear collar clockwise.

36V Cordless Hammer Drill

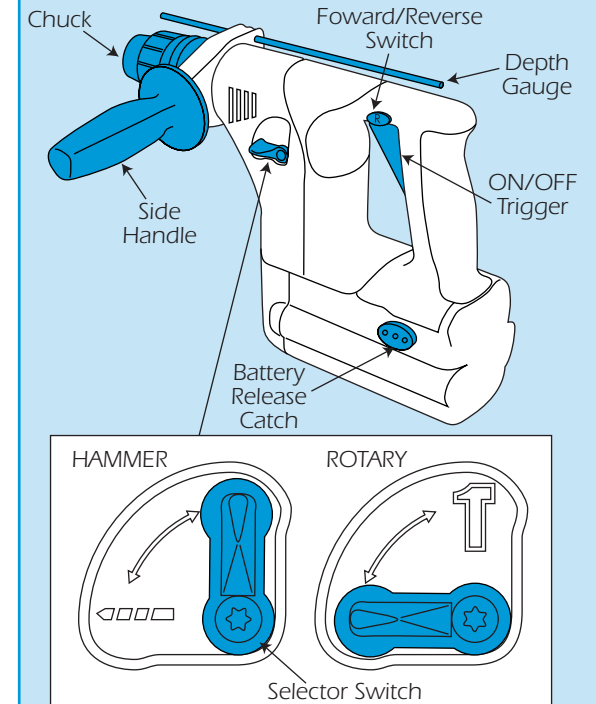

If the depth stop is to be used, this may be set by twisting the side handle to loosen/tighten the depth rod's guide.

If drilling into masonry, set the drill to 'hammer', the hammer action is turned on and off with the selector lever.

Chuck

