

HSS Hire Shops

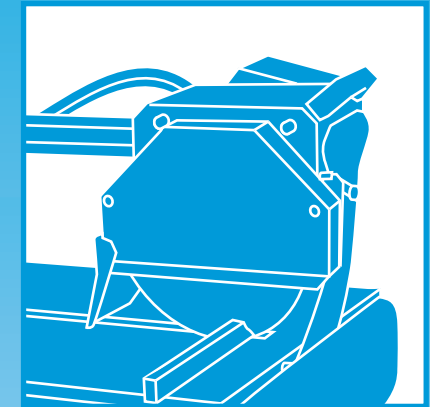

Tile Saw Bench

For cutting ceramic tiles up to 60mm thick and 600mm long.

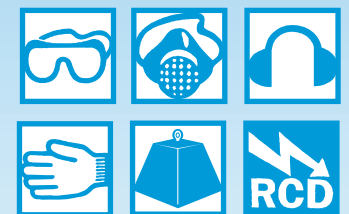

Code 07421

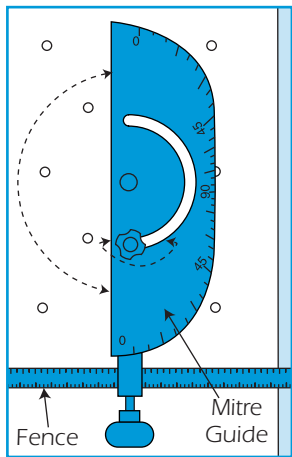

For normal straight cuts, rest the tile against the fence. Where the same cut has to be made in several tiles, set the guide at 90° to the fence and lock in position as required.

If a mitred cut is required set the guide at the required angle and again, lock in position as required.

To set a bevelled mitre, release the carriage lock lever, tilt the carriage to the left by 45° and re-engage the lock lever.

Set the mitre angle and width setting as required then lay the tile (outer face up) on the bed. Switch the unit ON, then double check for a good water flow.

To achieve a cut, pull the cutting head towards you by its handle. Pass the blade through the tile exerting a constant amount of pressure suitable for the material being cut.

Make sure you keep your hands clear of the blade at all times. Don't be fooled, the diamond blade is of a smooth appearance, but it can still cut you.

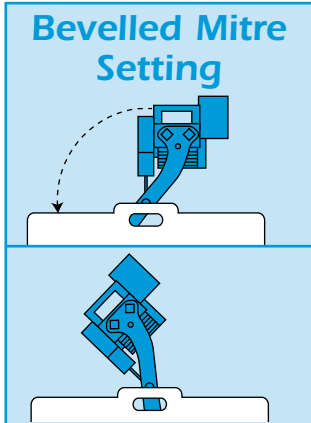

EQUIPMENT CARE

Never push the equipment beyond its design limits. If it will not do what you want with reasonable ease, assume you have the wrong equipment for the job. Contact your local HSS Hire Shop for advice.

Keep the equipment clean – you will find this less of a chore if you clean it regularly, rather than wait until the end of the hire period.

Check the water level in the base tray at regular intervals, never allow the blade to become dry, top up as necessary.

The base tray should be emptied and cleaned at the end of each work session, more often if carrying out a large amount of work.

When not in use, store the equipment somewhere clean, dry and safe from thieves. Protect this equipment from frost and freezing conditions.

FINISHING OFF

Switch the unit OFF, disconnect it from the power supply and remove any tile off cuts.

If necessary set and lock the carriage at 90° then slide the cutting head back and lock in the transport position. Remove the unit followed by the base tray then fold up the stand.

Lastly, give everything a final clean up ready for return, to your local HSS Hire Shop.



...any comments?

If you have any suggestions to enable us to improve the information within this guide please fax your comments or write to the Product Manager at the address below

Fax: 020 8687 5001

©HSS Hire Service Group Plc 1999 No. 896/01
Group Office: 25 Willow Lane, Mitcham, Surrey CR4 4TS

Web Site: <http://www.hss.co.uk>

GENERAL SAFETY

For advice on the safety and suitability of this equipment contact your local HSS Hire Shop.

There is a serious risk of personal injury if you do not follow all instructions laid down in this guide.

This equipment should be used by an able bodied, competent adult who has read and understood these instructions. Anyone with either a temporary or permanent disability, should seek expert advice before using it.

Keep children, animals and bystanders away from the work area.

 Never use this equipment if you are ill, feeling tired, or under the influence of alcohol or drugs.

 Safety goggles MUST be worn by everyone in the work area.

 Some materials when cut contain substances which, when inhaled, can be harmful to health. A suitable mask must be worn when using this equipment.

 This equipment generates potentially harmful noise levels. To comply with health and safety at work regulations, ear defenders must be worn by everyone in the vicinity.

 Wear practical, protective clothing, gloves and footwear. Avoid loose garments and jewellery that could catch in moving parts, tie back long hair.

 This equipment is heavy, never attempt to lift it on your own, always get help.

Always switch OFF the equipment when not in use.

Ensure the work area is well lit, if in doubt ask about lighting equipment at your local HSS Hire Shop.

Do not work near flammable gases or liquids, petrol or paint thinner fumes for example. Keep combustible materials at a safe distance – at least 5m.

Make sure you know how to switch this machine OFF before you switch it ON in case you get into difficulty.

Check the condition of the equipment before use. If it shows signs of damage or excessive wear, return it to your local HSS Hire Shop.

Ensure the guard is correctly fitted and secure before starting work.

ELECTRICAL SAFETY

The HSS 250mm Tile Saw must be provided with a suitable 110V generated supply, or be powered from the mains via a suitable 110V transformer.

If the equipment fails, or if its power supply cable or plug becomes damaged, return it. Never try to repair it yourself.

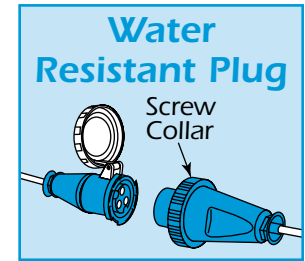

This equipment has a 16A 110V power supply plug, fitted with a water resistant screw collar. ONLY use extension leads fitted with this type of plug/socket configuration. Available for hire from your local HSS Hire Shop.

Extension leads should be fully unwound and loosely coiled, away from the equipment. Never run them through water, over sharp edges or where they could trip someone.

Keep cables out of harm's way, and clear of the work area.

 To reduce the risk of electric shock, always use a suitable RCD (Residual Current-Operated Device) available from your local HSS Hire Shop.

This equipment is fitted with an NVR (No Volt Return) switch. The switch will only stay in the ON position if there is a power supply. If the power supply is interrupted, for whatever reason, the switch will move to the OFF position. This safeguards the user, as the machine will not start without warning when the power is restored.

Ensure the power socket is switched OFF before plugging into the power supply.

GETTING STARTED

Unfold the stand with the base plates on the floor, positioned so the Tile saw will be facing the required direction. Because the unit uses water to cool and lubricate the blade, it must be positioned away from electrical services.

Next, check the stand is level with all four legs in contact with the ground.

If you wish, you may secure the stand to the floor using suitable fixings through the holes in the base plates.

Place the base tray onto the stand ensuring the stand's two cross bars fit into the tray's locating slots. It is important that the pump recess is at the opposite end to the operator (see illustration).

With the help of a colleague, position the Saw into the tray, making sure that the pump access hole is over the pump recess.

Fill the tray with fresh clean water (approximately 30 litres) ensuring that the pump and the pump recess

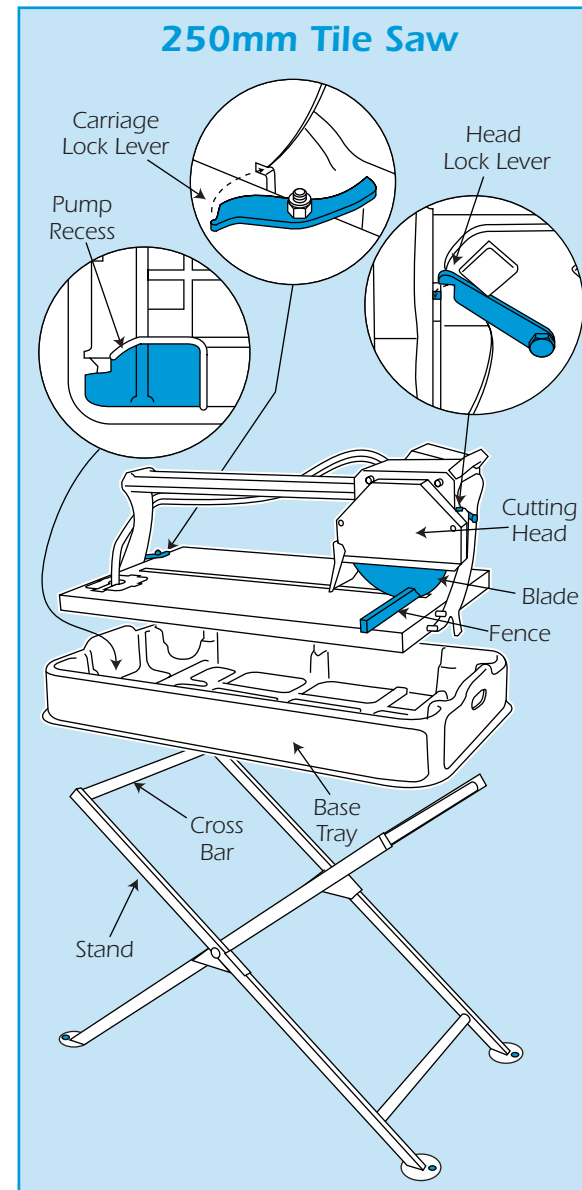

are covered. During use, some water will be lost through splashing etc. There must be enough water in the tray at all times, therefore it is important that the level is checked after every 10th tile is cut.

Pass the pump through the pump access hole and replace the cover plate.

All that now remains is to connect the unit to its power supply (please see ELECTRICAL SAFETY for important information on power supply requirements) and switch the supply ON.

Placing the Pump

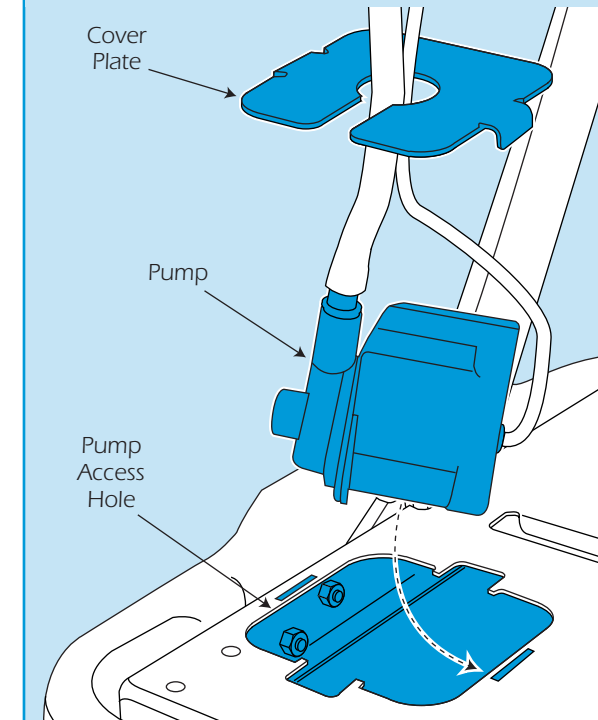

BASIC TECHNIQUES

Cutting Direction

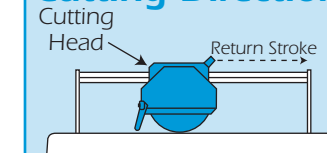

This machine is designed to cut on the return stroke, that is to say that the blade is pulled back towards you for the cut. Before you cut a tile and as soon as the cut is complete, the cutting head must be moved fully forward.

During transportation the head is locked in position, to release the head raise the lock lever and push the head forward.

NVR Switch

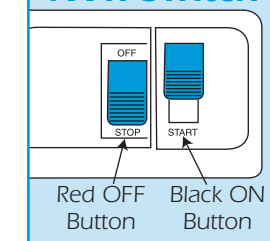

To switch the unit ON press the black ON button, to switch OFF press the red OFF button.

With the tile saw connected to its power supply, switch the unit ON and confirm that there is a good flow of water to both sides of the blade, then switch the unit OFF.