

HSS Hire



Hilti M-Class Dust Extractor

Ideal for collecting large quantities of
dry dust.



Code 52538

CAUTION

The material collected must be disposed of in accordance with the applicable regulations.
NOT SUITABLE FOR ASBESTOS.

WARNING

Never use the appliance without a filter element.

When fitting the top section of the dust extractor, take care to avoid pinching your fingers or damaging the supply cord.

Check to ensure that the filter element is dry. A damp filter element will quickly become clogged when dry dust is picked up with the appliance. Accordingly, before being used for picking up dry dust, the filter element should be rinsed and allowed to dry or replaced with another dry filter element.

CHANGING PAPER DUST BAG / FILTER FLEECE

CAUTION

When changing the paper dust bag or filter fleece, check that the bag has not been pierced through by objects which may cause injury.

Every time when changing the paper dust bag or filter fleece **disconnect the supply cord plug from the power outlet**. Open the top section and **carefully remove the paper dust bag collar from the adapter and remove the filter fleece**. Close the slider at the dust bag collar (place the cover over the filter fleece). Clean the waste material container. Finally fit a new dust bag / filter fleece in the waste material container. Now place back top section of the dust extractor. Make sure to close the catches on both sides.

WARNING

Never use paper dust bag for collecting slurry

EQUIPMENT CARE

TRANSPORTATION

Take care to ensure that the hose socket cap is fitted when the appliance is transported or not in use.

Do not carry the appliance when it is full of waste material. Empty the appliance before carrying it to another location.

Do not tip the appliance or lay it on its side for transport after using it to collect water.

The tapered adapter can be used to connect both ends of the hose together for transport.

Do not use the appliance where there is a risk of fire or explosion, or where there is a high risk of damage.

Never push the equipment beyond its design limits. If it will not do what you want with reasonable ease and speed, assume you have the wrong equipment for the job. Contact HSS Hire for advice.

Keep the equipment clean - you will find this less of a chore if you clean it regularly, rather than wait until the end of the hire period.

When not in use, store the equipment somewhere clean, dry and secure.

FINISHING OFF

Switch OFF and unplug the dust extractor.

Disconnect the hose. Dispose of the dust collection bag in accordance with the applicable regulations. Clean the unit including the filter carefully.

Tidy up and stow the supply cord, extension cord and suction hose away securely. This will reduce the risk of tripping and falling.

Give the tool a final clean up ready for return, to HSS Hire.



... have you been trained

The law requires that personnel using this type of equipment in the workplace must be competent and qualified to do so.
Training is available at HSS Training
0845 766 7799

...any comments?

If you have any suggestions to enable us to improve the information within this guide please e-mail your comments or write to the Safety Guide Manager at the address below
e-mail: safety@hss.com

©HSS Hire Service Group Ltd 2020 No. 339/02

76 Talbot Road, Old Trafford, Manchester, M16 0PQ

www.hss.com

GENERAL SAFETY

For advice on the safety and suitability of this equipment contact HSS Hire.

There is a serious risk of personal injury if you do not follow all instructions laid down in this guide.

The hirer has a responsibility to ensure that all necessary risk assessments have been completed prior to the use of this equipment.



Keep the work area tidy. Any objects which may cause injury should be removed from the area. Untidiness at the workplace can lead to accidents.

This equipment should only be used by an operator who has been deemed competent to do so by his/her employer.

This equipment should be used by a competent adult who has read and understood these instructions.

Anyone with either a temporary or permanent disability, should seek expert advice before using it.

Keep children, animals and bystanders away from the work area. Cordon off a NO GO area using cones and either barriers or tape, available for hire from HSS Hire.

  Never use this equipment if you are ill, feeling tired, or under the influence of alcohol or drugs.

 Wear practical, protective clothing and gloves. Avoid loose garments and jewellery that could catch in moving parts, tie back long hair.

 Always wear eye protection. Safety equipment such as dust mask, non-skid safety shoes, hard hat, or hearing protection used for appropriate conditions will reduce personal injuries.

Make sure you work from a safe stance and stay in balance at all times.

If devices are provided for the connection of dust extraction and collection facilities, ensure these are connected and properly used. Use of these devices can reduce dust-related hazards.

Always switch off and unplug everything before attempting to service or adjust the unit.

Never use this equipment for removing asbestos or any other hazardous material.

Do not push anything into the openings on the appliance. Do not work with the appliance if the openings are blocked. Keep the openings free from dust, fluff, hair or anything else that could obstruct the flow of air.

Dry use only, do not pick up oil or liquids .

In very dusty environment, steps must be taken to ensure adequate air exchange in the room if the

exhaust air from the appliance is released into the room - please observe the locally applicable regulations.

Don't leave the dust extractor unattended whilst on.

Do not operate the appliance when laid on its side. Always operate in upright position.

Do not stand on the unit; do not use as a substitute for a ladder.

To avoid the risk of injury, use only tools and accessories recommended by HSS Hire.

Avoid positioning the suction aperture next to delicate parts of the body such as eyes, mouth, ears, etc..

Do not expose appliances to rain or wet conditions. Water entering an appliance will increase the risk of electric shock.

Never clean the unit under flowing water

Always lead the supply cord, the extension cord and the suction hose away to the rear when working. This will help to prevent tripping while working.

Stay alert, watch what you are doing and use common sense when operating the appliance.

Do not pull the wheels of the dust extractor over the supply cord.

Check the equipment before use, if it shows signs of damage or excessive wear, return it.

Do not try to repair or modify the equipment. If this tool can't do what you expect or fails to work return to HSS Hire.

ELECTRICAL SAFETY

The HSS Hilti M-Class Dust Extractor plugs into a standard 110V 16amp power socket.

If the equipment fails, or if its power supply cable or plug becomes damaged, return it. Never try to repair it yourself.

Keep cables out of harm's way, and clear of the work area.

Extension leads should be fully unwound and loosely coiled, away from the equipment. Never run them through water, over sharp edges or where they could trip someone.

Remove the plug from the power socket before undertaking any type of intervention on the HSS Hilti M-Class Dust Extractor or if it is left unattended.

Check to ensure that the appliance is switched off before plugging the supply cord into a power outlet.

Before removing the plug, switch off the machine.

Always when unplugging pull the plug, not the power cord.

 To reduce the risk of electric shock, always use a suitable RCD (Residual Current-Operated Device) available from HSS Hire.

Ensure the machine and power socket are switched OFF before plugging into the power supply.

IDENTIFIER

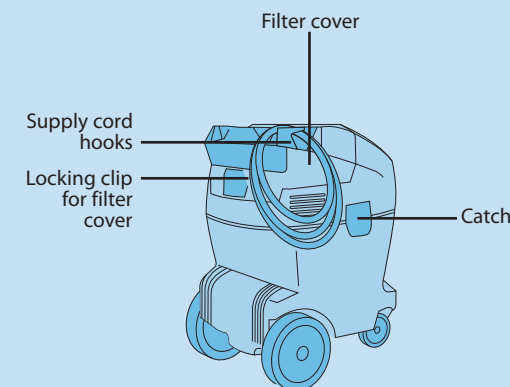
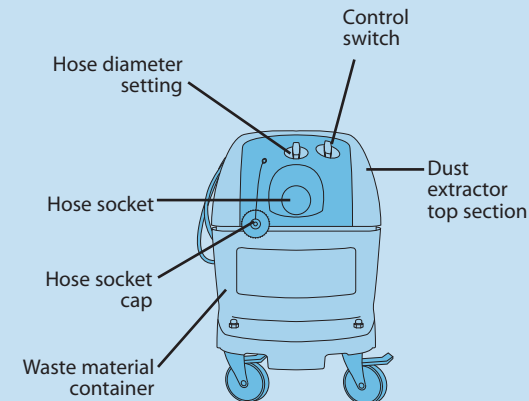

GETTING STARTED

The HSS Hilti M-Class Dust Extractor is designed for collecting large quantities of dry mineral dust when working with grinders and cutters, rotary hammers and dry cutting core bits.

WARNING NOT SUITABLE FOR ASBESTOS.

Never use the HSS Hilti M-Class Dust Extractor until you have fully read and understood this User Guide and the machine has been properly set up using the information it contains.

If operating the appliance for the first time, open the two catches and lift the dust extractor top section away from the waste material container.



Remove the accessories and packaging from the waste material container.

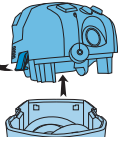

FITTING A PAPER DUST BAG

Paper bag is dedicated only for picking up dust. To fit the bag open the two catches and lift the dust extractor top section away from the waste material container.

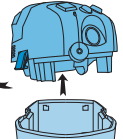

Place the new paper dust bag in the waste material container.

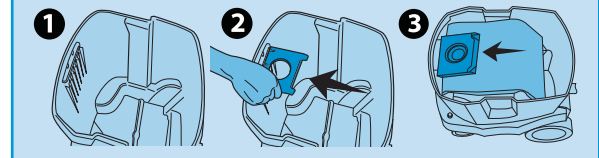

Fit the dust extractor top section onto the waste material container and close the two catches. Check to ensure that

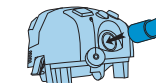

the top section is fitted correctly and secured. Connect the suction hose to the appliance.

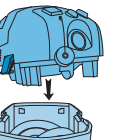

BASIC TECHNIQUES

Always check to ensure that the dust extractor is standing securely. Engage the castor brakes, plug in unit to power outlet and switch it on by turning the control switch to the "ON" position.

COLLECTING DRY DUST

This unit is intended for collecting dry dust.

Before using the appliance to pick up dry dust, especially dust from mineral materials, always check to ensure that the correct dust bag (accessory available from HSS Hire) is fitted in the container. The material collected can then be disposed of cleanly and easily.

Know Your Symbols

HSS have created clear Icons to inform the hirer of their responsibilities towards the safe use of hire equipment.

These are designed to reduce the amount of different safety information labels required for each product for hire.

General use PPE / Warning

Clearly marked minimum PPE will be visible on all equipment,



Correct PPE must be worn



HAV Hand Arm Vibration



Danger Rotating blade



Danger Hot exhaust



Danger Electric shock



Caution Abrasive Wheel



Caution Finger trap

Fuel and Supply Types



Pe
Petrol



Di
Diesel



2t
2 - Stroke Petrol



EI
Electric

Safe Procedures

All hirers must understand and respect the safe procedures of all equipment.

It is the responsibility of the hirer to maintain and return the equipment in a clean condition and good working order.



Ro
Read OPS Guide



Ou
Outdoor Use only



HI
Heavy Lifting



Cd
Check Oil daily



Cf
Check Fuel daily



Cw
Check Water daily



Bc
Battery Care



Sh
Safe Height Working



Swl
Refer to Data Plate



V
Check Power Voltage Data Plate

Electrical Safety

Safe wiring procedures.



Ea
Must be Earthed Class 1

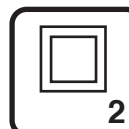

Doi
Double Insulated Class 2



Enl
Earth Live Neutral Wire Coding

Return Responsibility

Charges apply to equipment returned dirty and damaged.



Cc
Cleaning Charge



Rc
Repair Charge