

HSS Hire

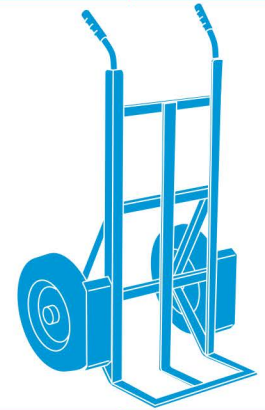

Trolleys

A wide selection of trolleys to suit most applications.

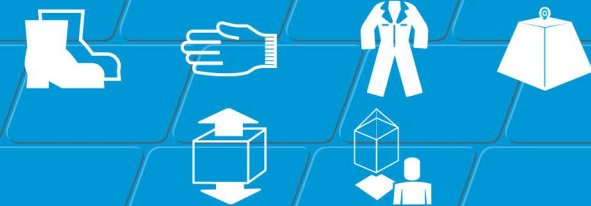

Code 70460/2/801/2/8/9/90
70502 / 70505

Place the load with the longest edge horizontal to the trolley, positioned centrally and with its bottom edge close to the base of the support bar. If possible, secure the load with suitable strapping.

BASIC TECHNIQUES

DO NOT use on slopes, soft ground or where there is a risk of subsiding.

When loading and unloading, make sure that the weight is evenly distributed or the load may overbalance.

Place the load as far back on the bed as possible and centre it across the width. Never exceed the units SWL, especially when using a stair climbing trolley.

It is advisable to strap the load to the unit before attempting to tilt back on the wheels.

Take your time and don't overdo it. You are more likely to have an accident if you are tired or rushing.

EQUIPMENT CARE

Never push the equipment beyond its design limits. If it will not do what you want with reasonable ease and speed, assume you have the wrong tool for the job. Contact your local HSS Hire for advice.

Keep the equipment clean, you will find this less of a chore if you clean it regularly, rather than wait until the end of the hire period.

Never wheel this type of equipment over rough ground unless specifically designed to do so. It will damage the equipment and could prove to be extremely dangerous.

When not in use, store the equipment somewhere clean, dry and safe from thieves and unauthorised users.

FINISHING OFF

Gently lower the load and then remove it from the trolley.

Where applicable, fold the unit up by reversing the instruction in GETTING STARTED. Give the trolley a final clean up ready for return, to your local HSS Hire.



... have you been trained

The law requires that personnel using work equipment have received adequate training and must be competent when using the equipment within the workplace. Training is available at HSS Training Solutions
0845 766 7799

...any comments?

If you have any suggestions to enable us to improve the information within this guide please e-mail your comments or write to the Safety Guide Manager at the address below
e-mail: safety@hss.com

©HSS Hire Service Group Ltd 2020 No. 026/04
76 Talbot Road, Old Trafford, Manchester, M16 0PQ

www.hss.com

GENERAL SAFETY



For advice on the safety and suitability of this equipment contact your local HSS Hire.



This equipment should only be used by an operator who has been deemed competent to do so by his/her employer.

There is a serious risk of personal injury if you do not follow all instructions laid down in this guide.

This equipment is designed to be used by an able bodied, competent adult who has read and understood these instructions. Anyone with either a temporary or permanent disability should seek expert advice before using it.

Keep children, animals and bystanders away from the work area. Cordon off a NO GO area using cones and either barriers or tape, available for hire from your local HSS Hire.

  Never use this equipment if you are ill, feeling tired, or under the influence of alcohol or drugs.

   Wear practical, protective clothing, gloves and footwear. Avoid loose garments and jewellery that could catch in moving parts, tie back long hair.

 This equipment is capable of transporting heavy objects, always get help lifting items onto the trolley if it is heavier than 25Kg.

 Use this equipment for vertical lifts only and use on a level area able to take the combined weight of the load and the equipment.

 Ensure the load is balanced and stable and that personnel stand clear of the raised load.

Make sure you know how to operate this equipment safely and are aware of its limitations before you use it.

It is both the hirer's and the operator's responsibility to perform a risk assessment before using this equipment. You are also responsible for the safety of any person in the work area.

Warning

This equipment MUST NOT be used to carry personnel.

Make sure that anyone in the immediate work area is warned of what you are doing.

Never leave a load unattended.

Ensure the work area is well lit and ventilated.

Safe Working Load

CODE	Description	SWL
70460	Three Way	200kg
70462	Appliance	200kg
70480	Sack	200kg
70481	Rough Terrain	200kg
70482	Panel	100kg
70488	4 wheel Panel Trolley	350kg
70489	4 wheel Compact Panel Trolley	350kg
70490	Stair Climbing	50kg
70502	Panel Trolley	350kg
70505	H/D Panel Trolley	750kg

Use the equipment only on firm, level ground. When moving loads keep to a sensible pace. If you go too fast, or if you try to wheel a heavy load down a slope, it could run away with you.

NEVER EXCEED the equipment's safe working load, see chart. Check the condition of the equipment before use. If it shows signs of damage or excessive wear, return it to your local HSS Hire.

GETTING STARTED

Three Way Trolley

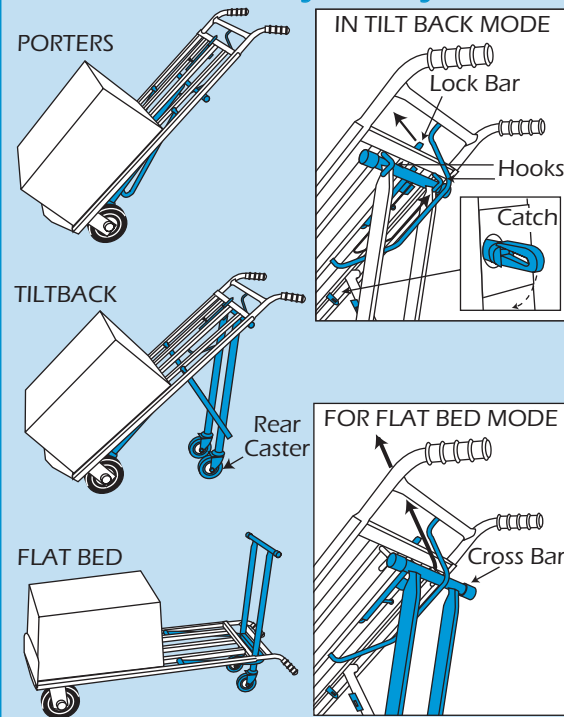

Stair Climbing Trolley

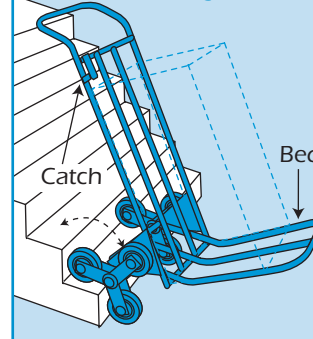

Appliance Trolley

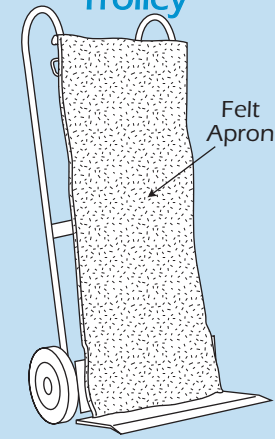

Rough Terrain Trolley

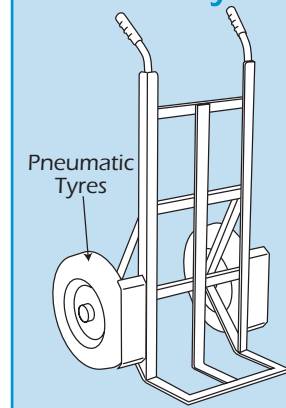

If using a THREE WAY TROLLEY...

As supplied, it can be used as a porter's trolley for light loads.

For heavier loads, tilt the trolley back onto the rear castors. Hinge out the back frame (it's held by a catch) and lock its cross-bar under the hooks on the main frame. Ensure the hinged locking bar on the main frame engages to hold it in place.

For the larger size load, convert the trolley into a flat-bed. Release the locking bar, slide the crossbar from under the hooks and up towards the main hand grips until it slips through the trolley's main frame. Lower the frame completely flat and adjust the crossbar to form a towing handle.

If using a STAIR CLIMBING TROLLEY...

Unclip the bed by lifting the catch at the top of the frame and lower carefully.

If using an APPLIANCE TROLLEY...

It is fitted with a felt apron to protect the load from being scratched.

Check the condition of the felt apron before loading. If it is damaged, contact your local HSS Hire for a replacement.

If using a ROUGH TERRAIN TROLLEY...

Ensure the tyres are correctly inflated.

Four Wheel Panel Trolley

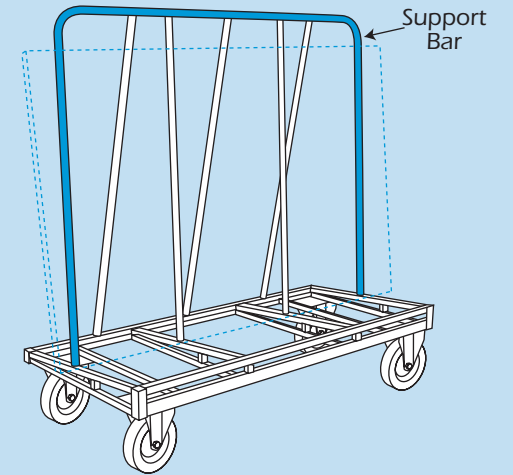

Heavy Duty Panel Trolley



If using a PANEL TROLLEY...

The HSS panel and compact panel trollies are designed for transporting sheet material, however, it is not advisable to use them for sheet glass.

Know Your Symbols

HSS have created clear Icons to inform the hirer of their responsibilities towards the safe use of hire equipment.

These are designed to reduce the amount of different safety information labels required for each product for hire.

General use PPE / Warning

Clearly marked minimum PPE will be visible on all equipment,



Correct PPE must be worn



HAV Hand Arm Vibration



Danger Rotating blade



Danger Hot exhaust

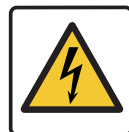

Danger Electric shock



Caution Abrasive Wheel



Caution Finger trap

Fuel and Supply Types



Pe
Petrol



Di
Diesel



2t
2 - Stroke Petrol



EI
Electric

Safe Procedures

All hirers must understand and respect the safe procedures of all equipment.

It is the responsibility of the hirer to maintain and return the equipment in a clean condition and good working order.



Ro
Read OPS Guide



Ou
Outdoor Use only



Hi
Heavy Lifting



Cd
Check Oil daily



Cf
Check Fuel daily



Cw
Check Water daily



Bc
Battery Care



Sh
Safe Height Working



Swl
Refer to Data Plate



V
Check Power Voltage Data Plate

Electrical Safety

Safe wiring procedures.



Ea
Must be Earthed Class 1

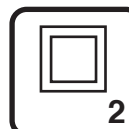

Doi
Double Insulated Class 2



Enl
Earth Live Neutral Wire Coding

Return Responsibility

Charges apply to equipment returned dirty and damaged.



Cc
Cleaning Charge



Rc
Repair Charge