

Keep the equipment clean, you will find this less of a chore if you clean it regularly, rather than wait until the end of the hire period.

When not in use, **store the equipment somewhere clean, dry and safe** from thieves.

FINISHING OFF

If using a manual type unit, release the wing nut on the crack handle and close it ensuring you re-tighten the wing nut securely. Push in the extension leg, then lower the handle fully.

If using a Hydraulic unit, insert the pump handle over the rams release valve, turn 1/4 anti-clockwise and allow the ram to fully close before re-tightening the valve. Place the handle in its transport holster.

All that remains is to give the unit a final clean ready for return to your local HSS Hire.



... have you been trained

The law requires that personnel using this type of equipment in the workplace must be competent and qualified to do so.

Training is available at HSS Training
0845 766 7799

...any comments?

If you have any suggestions to enable us to improve the information within this guide please e-mail your comments or write to the Safety Guide Manager at the address below
e-mail: safety@hss.com

©HSS Hire Service Group Ltd 2022 No. 736/02

Building Two, Think Park, Mosley Road,

Trafford Park, Manchester, M17 1FQ



www.hss.com

GENERAL SAFETY



For advice on the safety and suitability of this equipment contact your local HSS Hire.

This equipment should be used by an able bodied, competent adult who has read and understood these instructions. Anyone with either a temporary or permanent disability, should seek expert advice before using it.

Keep children, animals and bystanders away from the work area.

  Never use this equipment if you are ill, feeling tired, or under the influence of alcohol or drugs.

 Safety Goggles MUST be worn by everyone in the work area.

  Wear practical, protective clothing, gloves and footwear. Avoid loose garments and jewellery that could get in the way, tie back long hair.

 This equipment is heavy, never attempt to lift a splitter on your own, always get help.

Never place your hands or feet between the cutters.

Keep the work area clear of off cuts at all times.

Check the condition of the equipment before use. If it shows signs of damage or excessive wear, return it to your local HSS Hire.

GETTING STARTED

Model	Max. Thickness	Max. Width
Slab/Hydraulic	235mm	650mm
Slab/Manual	230mm	490mm
Block/Manual	100mm	335mm

Choose an area to site the splitter which is both close to the work and the supply of blocks / slabs.

Ideally the ground should be firm and level, with enough room around the splitter for you to work.

Have a container available to put any unwanted off cuts in, this will help to keep the area tidy and safe.

If using a manual type unit...

Pull out the extension leg. Then release the wing nut on the crack handle and extend it ensuring you re-tighten the wing nut securely. Now raise the handle to open the jaws fully.

If using a Hydraulic unit...

Insert the pump handle over the rams release valve, turn 1/4 anti-clockwise and allow the ram to fully close before re-tightening the valve.

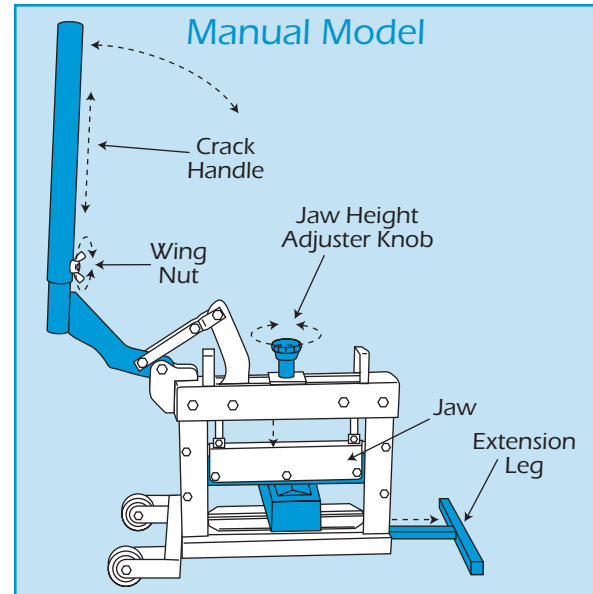

BASIC TECHNIQUES

Whatever you are splitting, the jaws of the unit must be adjusted to an opening approx. 3mm larger than the block / slab thickness.

To do this, place the item to be split central to the cutters jaws. Turn the adjuster handle / knob clockwise to lower and anti-clockwise to raise.

Once adjusted, make a test cut with the block / slab between the cutters.

With the manual model, firmly lower the handle until the block / slab splits. Then raise the handle ready for the next cut.

With the hydraulic model, pump the handle up and down until the block / slab splits. Then insert the pump handle over the rams release valve, turn 1/4 anti-clockwise and allow the ram to fully close before re-tightening the valve.

If the cut is correct, you can start to split as necessary.

EQUIPMENT CARE

Never push the equipment beyond its design limits. If it will not do what you want with reasonable ease, assume you have the wrong tool for the job. Contact your local HSS Hire for advice.

Keep the hydraulic unit upright at all times, if it should tip over, clear up any oil spillage's and contact your local HSS Hire for advice. DO NOT attempt to refill the rams oil reservoir.

Know Your Symbols

HSS have created clear Icons to inform the hirer of their responsibilities towards the safe use of hire equipment.

These are designed to reduce the amount of different safety information labels required for each product for hire.

General use PPE / Warning

Clearly marked minimum PPE will be visible on all equipment,



Correct PPE must be worn



HAV Hand Arm Vibration



Danger Rotating blade



Danger Hot exhaust



Danger Electric shock



Caution Abrasive Wheel



Caution Finger trap

Fuel and Supply Types



Pe
Petrol



Di
Diesel



2t
2 - Stroke Petrol



EI
Electric

Safe Procedures

All hirers must understand and respect the safe procedures of all equipment.

It is the responsibility of the hirer to maintain and return the equipment in a clean condition and good working order.



Ro
Read OPS Guide



Ou
Outdoor Use only



HI
Heavy Lifting



Cd
Check Oil daily



Cf
Check Fuel daily



Cw
Check Water daily



Bc
Battery Care

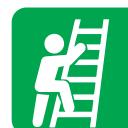

Sh
Safe Height Working



Swl
Refer to Data Plate



V
Check Power Voltage Data Plate

Electrical Safety

Safe wiring procedures.



Ea
Must be Earthed Class 1

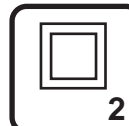

Doi
Double Insulated Class 2



Enl
Earth Live Neutral Wire Coding

Return Responsibility

Charges apply to equipment returned dirty and damaged.



Cc
Cleaning Charge



Rc
Repair Charge