

Contact your local HSS Hire for advice.

Keep the equipment clean. You will find this less of a chore if you clean it regularly, rather than wait until the end of the hire period.

When not in use, store the equipment somewhere clean, dry and safe from thieves.

Make sure that both the unit's air inlets and outlets are kept clear so that air circulates efficiently through the machine.

Note that the amount of water the unit can extract from the air will vary according to the room humidity and temperature. However, if it does not appear to be drying as it should for no obvious reason, contact your local HSS Hire for advice.

FINISHING OFF

Switch OFF and unplug the unit, allow the unit to stand for a minimum of 20 minutes before moving.

Neatly coil its flex to leave it ready for return to your local HSS Hire at the end of the hire period.



... have you been trained
 The law requires that personnel using this type of equipment in the workplace must be competent and qualified to do so. Training is available at HSS Training 0845 766 7799

...any comments?
 If you have any suggestions to enable us to improve the information within this guide please e-mail your comments or write to the Safety Guide Manager at the address below e-mail: safety@hss.com

©HSS Hire Service Group Ltd 2020 No. 538/02
 76 Talbot Road, Old Trafford, Manchester, M16 0PQ
www.hss.com

538/02

Operating & Safety Guide 538

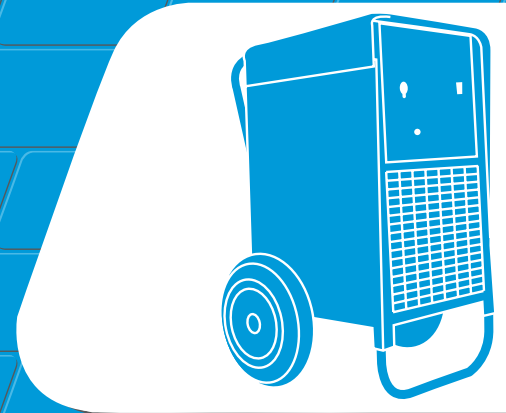

Industrial Dehumidifiers

Heavy-duty building dryers capable of extracting up to 80 litres per 24hrs dependent on room conditions



Code 56732 / 56733

GENERAL SAFETY

For advice on the safety and suitability of this equipment contact your local HSS Hire.

Keep children, animals and bystanders away from the work area.

Never use this equipment if you are ill, feeling tired, or under the influence of alcohol or drugs.

This equipment should only be used by a competent person who has read and understood these instructions.

Always transport and store the unit in an upright position, never lay it on its side.

When siting the unit, consider the floor surface. Avoid placing the unit on carpet, as the carpet may be damaged.

Check the condition of the equipment before use. If it shows signs of damage or excessive wear, return it to your local HSS Hire.

ELECTRICAL SAFETY

Most HSS dehumidifiers plug into a standard 240V, 13A power socket. However, 110V models (with a round, yellow plug) must be supplied from a 110V generator, or from the mains via a suitable transformer.

If the equipment fails, or if its plug or lead gets damaged, return it. Never try to repair it yourself.

Keep the flex out of harm's way, extension leads should be fully unwound and loosely coiled, away from the equipment. Never run them through water, over sharp edges or where they could trip someone.

Using electrical equipment in very damp or wet conditions can be dangerous.

 To reduce the risk of electric shock, use a suitable RCD (Residual Current-Operated Device) available from your local HSS Hire, or power 240V (Not 110V) equipment from a power circuit with a built-in RCD.

If the equipment fails, or if its plug or lead gets damaged, return it. Never attempt to repair it yourself.

Never carry or pull the equipment by its flex.

Ensure the machine and power socket are switched OFF before plugging into the power supply and when making any adjustments.

GETTING STARTED

A dehumidifier works by drawing warm moist air through the unit, cooling it to a temperature where the moisture will condense. The moisture is then collected ready for disposal via a hose.

If the dehumidifier is being used after flood damage, remove curtains, carpets and furniture from the room – for waterlogged carpets use a wet pickup vacuum, ask at your local HSS Hire for advice.

Set the unit up on a firm surface, either in the middle of the room or facing any specific wet patch.

Allow the unit to stand for a minimum of 20 minutes before switching ON.

Direct the drain hose into a suitable container or into a drain via a hosepipe.

Ensure hoses are kink-free and below the level of the dryer's outlet along their entire length – otherwise water extracted from the air will back up and flood the dryer.

If the hose is to be directed into a separate container, you must seal the top of the container and around the hose with cling film – otherwise the water collected will re-evaporate into the atmosphere and slow down the extraction process.

All windows and doors must be fully closed, and if possible, tape up all joints to stop air from outside entering the work area.

Now, plug the unit into its power supply and switch ON either by turning the ON/OFF switch to ON or by moving the voltage selection switch to the correct voltage (depending on the voltage set-up that you have requested) and pushing the start button.

BASIC TECHNIQUES

If the machine is draining into a container, empty this at regular intervals. At the same time, check on the amount of water the machine is extracting from the air. There will always be a certain amount because air naturally contains moisture, but the amount will become negligible as the room dries out.

EQUIPMENT CARE

Never use the equipment except for its intended purpose. If it will not do what you want with reasonable ease, assume you have the wrong equipment for the job.

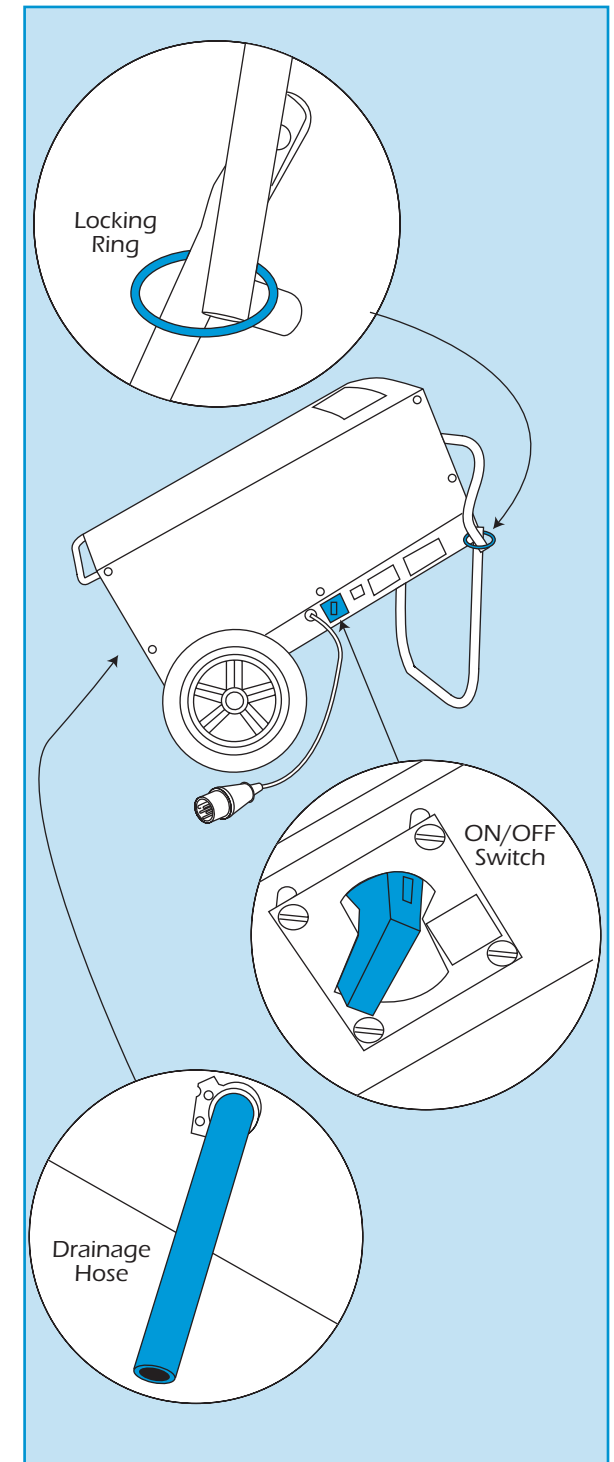

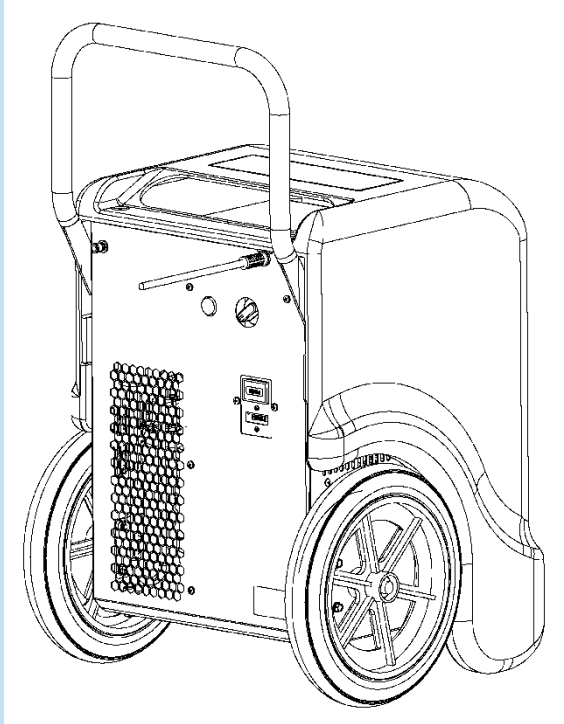

USER CONTROLS, DRAIN, AND AIR OUTLETS

- (A) Control panel (see Control Panel Detail below).
- (B) Condensate drain hose connector. Attach hose with quick-connect, then uncoil completely, ensuring there are no kinks or restrictions. Place end in drain or receptacle before operation.
- (C) Process air outlets. **IMPORTANT:** Do not block airflow.

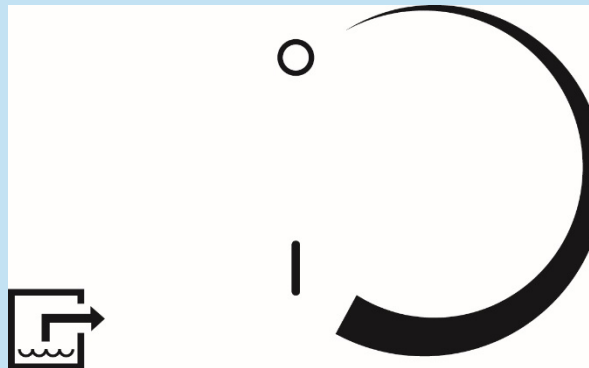

Control Panel Detail



Purge pump button. Press and hold to purge pump.



IMPORTANT

To help prevent drip tray overflow after using the dehumidifier, always purge the unit before moving.

1. Turn the unit off and allow the plugged in dehumidifier to rest for 10 minutes.
2. Press the  PURGE button. Hold until no more water is pumped out of the hose.
3. Remove the dehumidifier promptly from the job site.



Humidity control dial. Set to desired dehumidification level.

-  = Off
-  = Maximum dehumidification

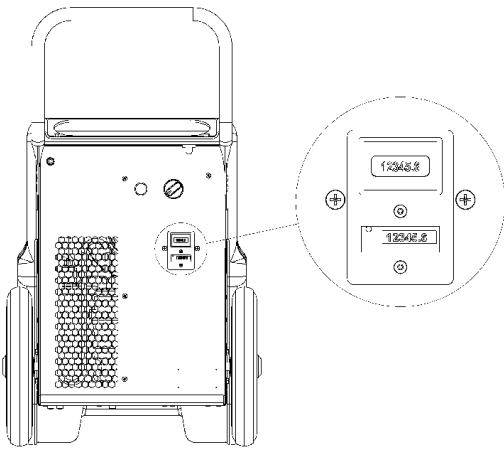

Storage & Transport

Store the building dryer vertically. If transported horizontally, position dryer in normal operating position and leave in place for 30 minutes to allow refrigerant to recirculate before use.

Know Your Symbols

HSS have created clear Icons to inform the hirer of their responsibilities towards the safe use of hire equipment.

These are designed to reduce the amount of different safety information labels required for each product for hire.

General use PPE / Warning

Clearly marked minimum PPE will be visible on all equipment,



Correct PPE must be worn



HAV Hand Arm Vibration



Danger Rotating blade



Danger Hot exhaust

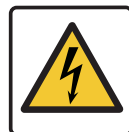

Danger Electric shock



Caution Abrasive Wheel



Caution Finger trap

Fuel and Supply Types



Pe
Petrol



Di
Diesel



2t
2 - Stroke Petrol



EI
Electric

Safe Procedures

All hirers must understand and respect the safe procedures of all equipment.

It is the responsibility of the hirer to maintain and return the equipment in a clean condition and good working order.



Ro
Read OPS Guide



Ou
Outdoor Use only



HI
Heavy Lifting



Cd
Check Oil daily



Cf
Check Fuel daily



Cw
Check Water daily



Bc
Battery Care

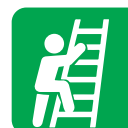

Sh
Safe Height Working



Swl
Refer to Data Plate



V
Check Power Voltage Data Plate

Electrical Safety

Safe wiring procedures.



Ea
Must be Earthed Class 1

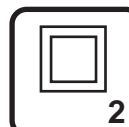

Doi
Double Insulated Class 2



Enl
Earth Live Neutral Wire Coding

Return Responsibility

Charges apply to equipment returned dirty and damaged.



Cc
Cleaning Charge



Rc
Repair Charge