

# HSS Hire

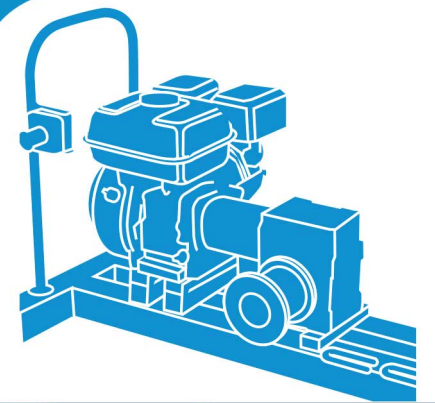

## Capstan Winch

A portable, petrol powered capstan winch for use over man holes and similar locations.



Code 70756

To start the engine, firstly re-set the red emergency STOP button if necessary. Turn the engine's ON/OFF switch to the ON position, open the fuel tap, then set the choke - fully closed if starting from cold, half closed if the engine has warmed up.

Set the engine's throttle half way then a few brisk pulls on the starter cord should now start the engine.

Once started, let the engine warm up for a few minutes before opening the choke and setting the throttle to idle.

Once warmed up, set the engine's ON/OFF switch to OFF.

### BASIC TECHNIQUES

Lower the end of a suitable rope (Sisal or Hemp, do not use rope constructed of man made material) down into the manhole until it touches the bottom.

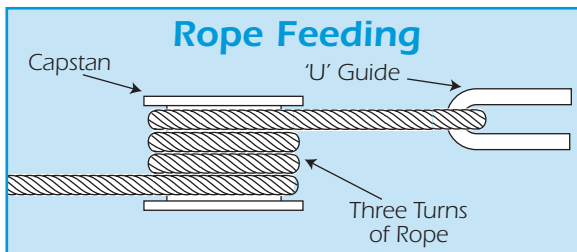

Slot the rope onto one of the three 'U' shaped guides, whichever one is closest to the load's position at the bottom of the manhole. The idea being that the rope is set as close to the vertical as possible.

Wind the rope onto the capstan, working from the 'U' guide. The rope should be wound on anticlockwise (over the top and back under) feed the rope from the inside of the capstan, a maximum of three turns, with the rope exiting from the top and towards the engine end of the unit (see illustration).

Securely attach the load to the rope making sure that it will be safe to lift.

Start the engine and set the throttle to approximately half way, if the capstan's speed is too fast or slow reset the throttle to suit.

Before continuing, make sure that you are wearing suitable protective gloves, failure to wear gloves may result in severe rope burns.

To raise the load, simply take a firm hold of the rope at the rear of the unit and exert a slight pulling force, the rope will tighten up on the capstan and the capstan will take up the load.

Note that the rope will only move if you are applying a pulling force.

Practice a few times with a dummy load until you get used to its operation.

Where a load is to be lowered, stop the engine and lower the rope manually using the capstan to create the drag forces required for slowing the ropes speed of descent.

Take your time and don't overdo it. You are more likely to have an accident if you are tired or rushing.

### EQUIPMENT CARE

Never push the equipment beyond its design limits. If it will not do what you want with reasonable ease and speed, assume you have the wrong tool for the job. Contact your local HSS Lift & Shift Depot for advice.

Regularly check the fuel level and top up as necessary with unleaded petrol.

Regularly check the oil level - when the engine is cold and on level ground. Withdraw the dipstick, wipe it clean, then replace it, remove it a second time and verify that the oil level is between the Min and Max lines, top up as necessary.

Keep the equipment clean, you will find this less of a chore if you clean it regularly, rather than wait until the end of the hire period.

When not in use, store the equipment somewhere clean, dry and safe from thieves and unauthorised users.

### FINISHING OFF

Gently lower any raised load, then switch the engine OFF.

Remove the rope from the capstan, neatly coil the rope and place somewhere safe.

Move the unit clear of the manhole opening then refit the cross bar into its transport stowage position.

Give the unit a final clean up ready for return, to your local Lift & Shift Depot.



#### ... have you been trained

The law requires that personnel using this type of equipment in the workplace must be competent and qualified to do so.

Training is available at HSS Training  
0845 766 7799

#### ...any comments?

If you have any suggestions to enable us to improve the information within this guide please e-mail your comments or write to the Safety Guide Manager at the address below  
e-mail: [safety@hss.com](mailto:safety@hss.com)

©HSS Hire Service Group Ltd 2020 No. LS059/01

76 Talbot Road, Old Trafford, Manchester, M16 0PQ

[www.hss.com](http://www.hss.com)

## GENERAL SAFETY

For advice on the safety and suitability of this equipment contact your local HSS Lift & Shift Depot.

There is a serious risk of personal injury if you do not follow all instructions laid down in this guide.

This equipment is designed to be used by an able bodied, competent adult who has read and understood these instructions. Anyone with either a temporary or permanent disability should seek expert advice before using it.

Keep children, animals and bystanders away from the work area. Cordon off a NO GO area using cones and either barriers or tape, available for hire from your local HSS Lift & Shift Depot.

 Never use this equipment if you are ill, feeling tired, or under the influence of alcohol or drugs.

 Wear practical, protective clothing, gloves and footwear. Avoid loose garments and jewellery that could catch in moving parts, tie back long hair.

 Use this equipment for vertical lifts only and use on a level area able to take the combined weight of the load and the equipment.

 May be used at any angle for lifting, dragging or pulling. Anchor to a safe, secure point able to take the load force applied. Allow for contact friction if dragging.

 This equipment is heavy (64kg), never attempt to lift it on your own, always get help.

Make sure you know how to operate this equipment safely and are aware of its limitations before you use it.

It is both the hirer's and the operator's responsibility to perform a risk assessment before using this equipment. You are also responsible for the safety of any person in the work area.

## Safety Warning

This equipment **MUST NOT** be used to carry or lift personnel.

Make sure that anyone in the immediate work area is warned of what you are doing.

Never exceed the equipment's safe working load of 500kg.

Always switch OFF the engine when not in use.

Ensure the work area is well lit and ventilated, if in doubt, ask about site lighting and fume extraction equipment at your local Lift & Shift Depot.

The capstan winch can cause serious injury. Always keep feet and hands well away from the capstan while the machine is running, taking special care when starting.

Engines, especially the exhausts, get very hot so switch OFF and allow too cool before touching them.

Do not work near flammable gases or liquids, petrol or paint thinner fumes for example. Keep combustible materials at a safe distance – at least 5m.

## Exhaust Danger

Never operate petrol engines indoors or in a confined space.

The exhaust contains gases that can kill.

## Fuel Safety

NEVER refuel while the engine is hot or running. NEVER smoke or allow naked lights into the refuelling area.

ALWAYS mop up spilt fuel quickly and change clothes if you get any on yourself. ALWAYS store fuel in suitable sealed containers, in a cool, safe place, well away from the work area.

Make sure you know how to switch this machine OFF before you switch it ON in case you get into difficulty.

Always stop the engine before making adjustments to the equipment.

Check the condition of the equipment before use. If it shows signs of damage or excessive wear, return it to your local HSS Lift & Shift Depot.

## GETTING STARTED

Place the unit next to the manhole then check the engine's oil and fuel levels.

Remove the cross bar from its transport stowage position, to do this, remove the 'R' clip on the retaining pin and slide the retaining pin out. Next remove the cross bar and re-insert into the rear of the chassis. Hold the cross bar in position by locating the retaining pin into the central guide hole and lock in place with the 'R' clip.

Where the unit's position is to be at an offset angle over the manhole, the cross bar can be set to the left or right as necessary.

## Capstan Winch

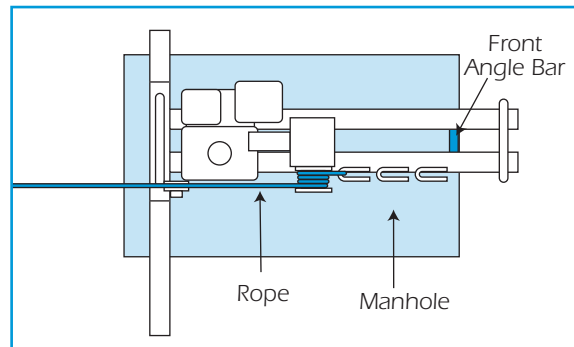
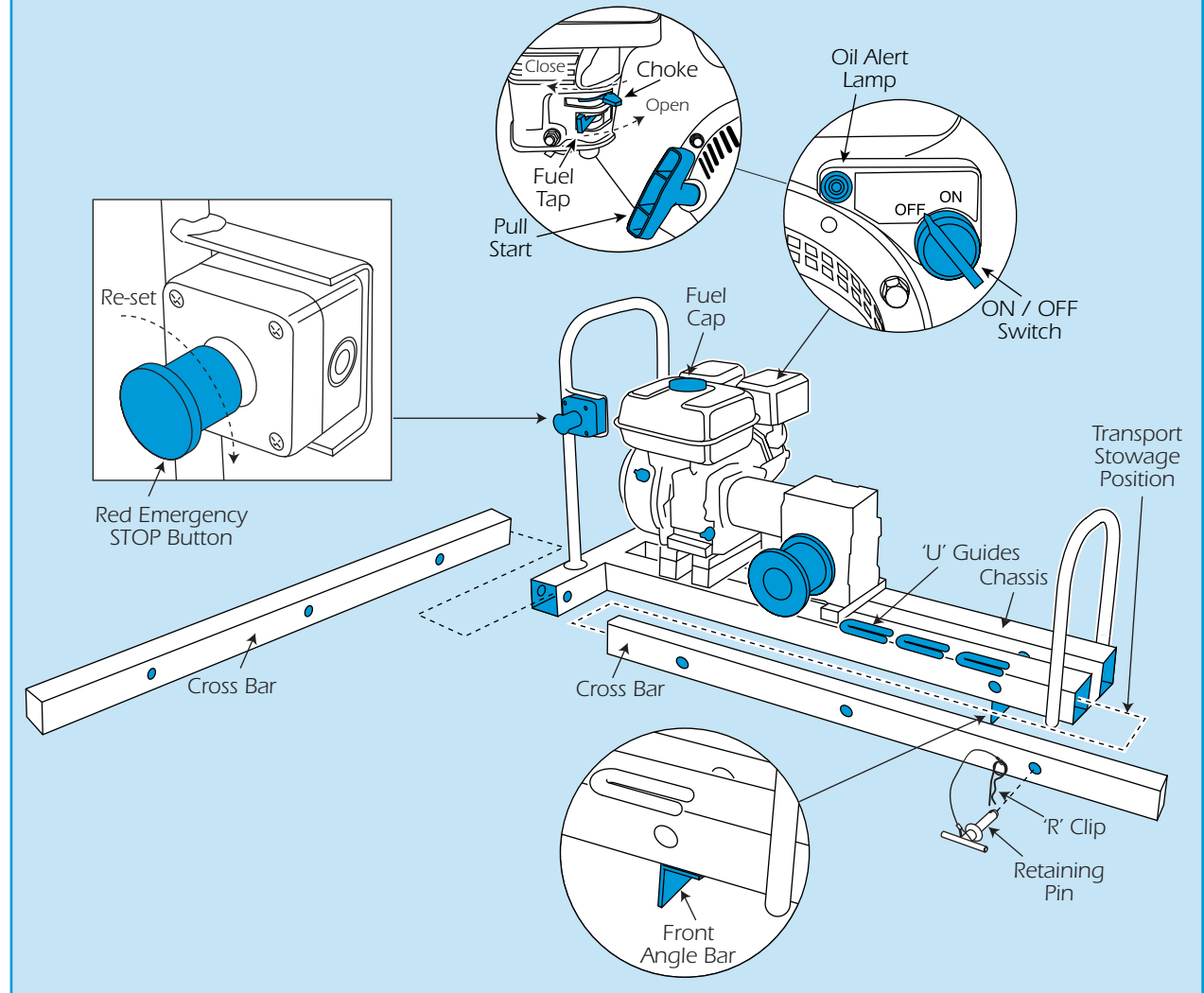

Remove the manhole cover and place the unit over the opening with the chassis's front angle bar set inside the lip of the manhole cover's frame.

Centralise the unit over the manhole and place a safety barrier around the area to safeguard against pedestrian accidents.

The unit is fitted with a red emergency STOP button, which stops the engine when pressed in. To reset the button, turn it clockwise until it pops out again.

Remember where the red emergency STOP button is, so that it can be operated quickly in an emergency.

# Know Your Symbols

HSS have created clear Icons to inform the hirer of their responsibilities towards the safe use of hire equipment.

These are designed to reduce the amount of different safety information labels required for each product for hire.

## General use PPE / Warning

Clearly marked minimum PPE will be visible on all equipment,



Correct PPE must be worn



HAV Hand Arm Vibration



Danger Rotating blade



Danger Hot exhaust



Danger Electric shock



Caution Abrasive Wheel



Caution Finger trap

## Fuel and Supply Types



Pe  
Petrol



Di  
Diesel



2t  
2 - Stroke Petrol



EI  
Electric

## Safe Procedures

All hirers must understand and respect the safe procedures of all equipment.

It is the responsibility of the hirer to maintain and return the equipment in a clean condition and good working order.



Ro  
Read OPS Guide



Ou  
Outdoor Use only



HI  
Heavy Lifting



Cd  
Check Oil daily



Cf  
Check Fuel daily



Cw  
Check Water daily



Bc  
Battery Care



Sh  
Safe Height Working



Swl  
Refer to Data Plate



V  
Check Power Voltage Data Plate

## Electrical Safety

Safe wiring procedures.



Ea  
Must be Earthed Class 1

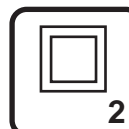

Doi  
Double Insulated Class 2



Enl  
Earth Live Neutral Wire Coding

## Return Responsibility

Charges apply to equipment returned dirty and damaged.



Cc  
Cleaning Charge



Rc  
Repair Charge